

SERIES:

MGDU4



3003 9th Avenue SW  
 PO Box 50  
 Watertown, SD 57201  
 Toll free: 888-978-2638  
 Ph: 605-886-3326  
 Fax: 605-886-8995



Low Profile, High Current Power Inductors

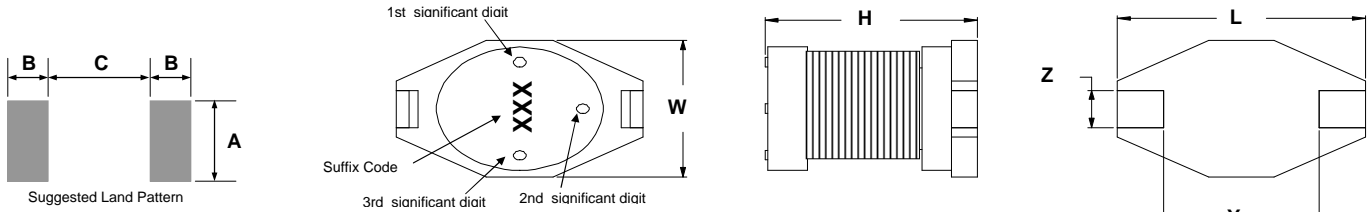

Parts will be marked with Significant Digit Dots OR Suffix code

Series Number	Maximum Dimensions			Reference Dimensions					
	Units	L	W	H	Y	Z	A	B	C
MGDU4	inches	0.510"	0.370"	0.450"	0.300"	0.100"	0.110"	0.115"	0.290"
	[ mm ]	[ 12.95 ]	[ 9.40 ]	[ 11.43 ]	[ 7.62 ]	[ 2.54 ]	[ 2.79 ]	[ 2.92 ]	[ 7.37 ]

**Features:**

- High energy storage and low resistance
- Ideal for DC-DC step-up or step-down conversion.
- Reliable surface mounting, flat top for pick and place mounting
- Robust temperature deflection to prevent damage during solder reflow.
- Operating Temperature -40°C to +85°C.



Terminal Plating is Gold Flash over Ni  
 260°C Maximum reflow temperature per J-STD020

**Notes:**

- Inductance measured at 100kHz, 100mVrms at 20°C.
- DCR (DC resistance) are maximum @ 20°C.
- Irms is the current applied to produce a typical 30°C temperature rise from nominal inductance.
- Isat is a maximum applied AC + DC current.
- Isat is the current applied to produce a typical 10% drop in nominal inductance
- Tolerance suffix of M = ±20%.

Schematic Diagram

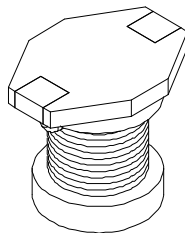
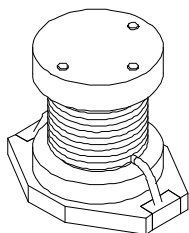
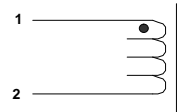

Contact CoEv for additional inductance values

MGDU4					
Lead Free Part Number	L μH	DCR	ISAT	IRMS	Tolerance
		W	A	A	Suffix
	1.0				
	1.5				
	2.2				
	3.3				
	4.7				
	5.6				
MGDU4-00001	6.8	0.015	10.00	5.00	M
	8.0				
MGDU4-00002	10	0.040	8.00	3.50	M
MGDU4-00003	15	0.050	7.00	3.00	M
MGDU4-00004	22	0.070	5.50	2.50	M
MGDU4-00005	33	0.080	4.00	2.00	M
MGDU4-00006	47	0.110	3.80	1.60	M
MGDU4-00007	68	0.170	3.00	1.20	M
MGDU4-00008	100	0.220	2.50	1.20	M
MGDU4-00009	150	0.340	2.00	0.90	M
MGDU4-00010	220	0.440	1.60	0.70	M
MGDU4-00011	330	0.700	1.20	0.60	M
MGDU4-00012	470	0.950	1.00	0.30	M
MGDU4-00013	680	1.200	1.00	0.20	M
MGDU4-00014	1000	2.000	0.80	0.10	M

Specifications subject to change

Call Toll Free: 888-978-2638 Website: [www.tycopowercomponents.com](http://www.tycopowercomponents.com)

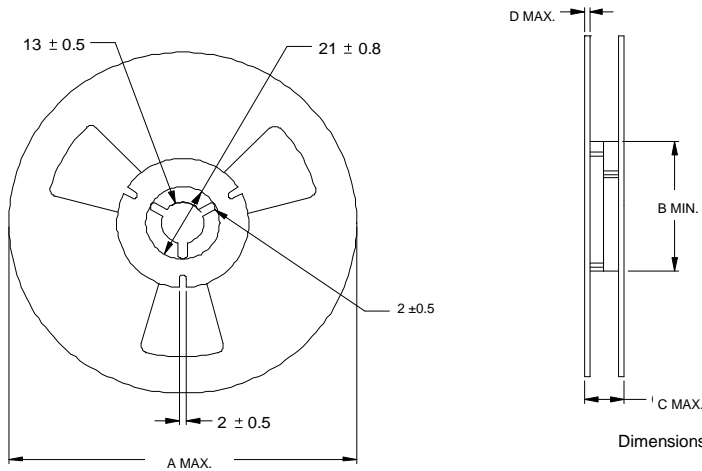

Dimensions are in millimeters unless specified.

Series Number	Reel dimensions				Reel Qty	Carton (Box) Qty.	Packaging Specification
	Units	A	B	C			
MGDU4	in.	14.17"	3.94"	0.88"	250	1000	90-0060
	[mm]	[ 360 ]	[ 100.0 ]	[ 22.4 ]			

PACKAGING NOTE: Only pressure sensitive cover tape is to be used.

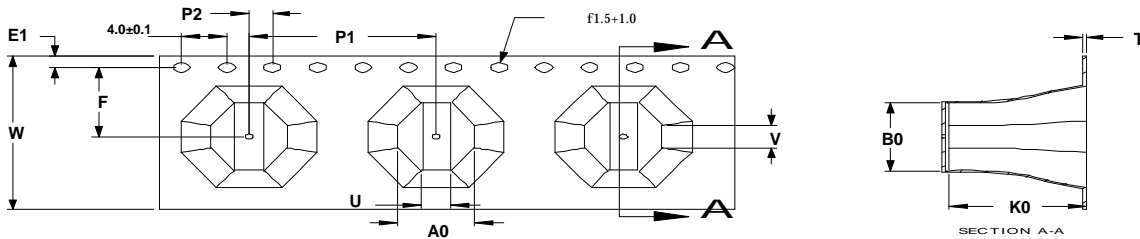
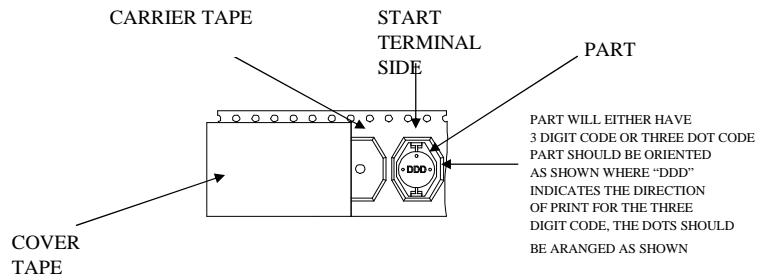

Series	A0 ± 0.1	U ± 0.1	V ± 0.1	P1 ± 0.1	P2 ± 0.1	W ± 0.3	F ± 0.1	E1 MIN.	B0 ± 0.1	K0 ± 0.05	T ± 0.05
MGDU4	10.20	3.90	4.00	12.00	2.00	24.00	11.50	1.75	13.10	11.60	0.35



**Customer Packaging Specifications**  
For Print Distribution to Customers

Series	Revision
MGDU4	A0
Sheet 2 of 7	

Item	Specification	Test Method/Condition
<b>Environmental</b>		
Static Humidity	After exposure part remains within specified electrical parameters for L, Q and DCR.	Expose parts to an environment of +50°C with 90 to 95% R.H. for 100 hours. After exposure, allow parts to dry for 2 hours before measurements are taken.
Storage Life	After exposure part remains within specified electrical parameters for L, Q and DCR.	Subject parts to an environment of +50°C 90 to 100% R.H. for 46 to 50 hours. After exposure, allow parts to dry for 2 hours before measurements are taken.
Moisture Resistance	After exposure, part shall not have a shorted or open winding.	Per MIL-STD 202 Method 106, ten 24 hour cycles at +25°C to +65°C at 80 to 95% R.H. During any of the first 9 cycles, inductors are revolved from the chamber and exposed to -10°C for 3 hours. Allow parts to dry for 2 hours before measurements are taken.
Temperature Cycle	After exposure part remains within specified electrical parameters for L, Q and DCR.	10 cycles (Air to Air) 1 cycle shall consist of: 30 minutes exposure to +85°C 30 minutes exposure to -40°C Allow 20 minutes transition between extremes.
Temperature Shock	After exposure part remains within specified electrical parameters for L, Q and DCR.	10 cycles (Air to Air) 1 cycle shall consist of: 30 minutes exposure to -45°C 30 minutes exposure to +125°C 15 seconds maximum transition between temperatures
<b>General</b>		
Storage Temperature Range	-40°C to +85°C	
Operating Temperature Range	-40°C to +85°C	
Flammability	IEC 695-2-2	Withstands needle-flame test
<b>Other</b>		
Vibration	After exposure part remains within specified electrical parameters for L, Q and DCR.	Inductors shall be randomly vibrated per NAVMAT P9492 profile. Samples shall be subjected to 0.04G/Hz for a minimum of 15 minutes per axis, for each of the three axes.
Mechanical Shock	After exposure part remains within specified electrical parameters for L, Q and DCR.	Test per MIL-STD 202 method 213 test condition A, test mounted samples 3 axes, 6 times, totaling 18 shocks. (50Gs, 11ms, half-sine).
Solderability	Wetting shall cover 90% minimum of	Dip pads in RMA flux, 63/37 solder (Sn/Pb) at 232°C for 5
Component Adhesion (Push Test)	4 pounds	Apply and measure force with a digital force gauge set.
Resistance to Solvent	No sign of degradation in appearance or marking detail.	Withstands 6 minutes of alcohol. Withstands 3 minutes forced spray Freon TMS
Load Life	After exposure, part shall not have a shorted or open winding.	Parts to be stored at 110°C for 1000 hours with rated current applied. Parts to be tested at: start, 500 and 1000 hours. Allow 2 hours at room temperature before testing.



<b>For Print Distribution to Customers</b>	<b>Series</b>	<b>Revision</b>
	<b>MGDU4</b>	<b>A0</b>
	Sheet 3 of 7	